



CMM

Measurement box



Main features

- ***Up to 4 analog inputs***
- ***Display on computer via Labview interface***
- ***Customizable interface***
- ***12 - 14 or 16 bits Resolution***
- ***Data transfer in a spreadsheet***
- ***Supply : 220V***

INTRODUCTION

The CMM measurement box allows to measure electrical and physical quantities (such as distances, forces, pressures, accelerations, couples), to display them on a computer and record these values in a spreadsheet.

MAIN FEATURES

Sensor

Analog inputs	Up to 4 inputs
Input signal	4 ... 20 mA / 0 ... 10 V
Resolution	12 - 14 or 16 bits
Power supply	220V
Connectique d'entrée capteur	Connecteur M16 - 8 broches DIN
Output connector	USB type B Connector
Box material	Anodized aluminum

MATERIAL PROVIDED

Measurement box



Supply cable



USB Cable
USB A male to USB B male



INTERFACE

Lecture de position du CD50-1250-1420-L15-C-OP-IX

Module connecté?

Position actuelle (mm)

Tension capteur

remise à zéro

Offset (mm)

annuler RAZ

acq/s

Démarrer acquisition

Stop acquisition

Temps actuel

Données

Exporter

Effacer tableau

AK Industries

Display of the sensor position

Sensor voltage measured at the module terminals

Preset values

Start / stop acquisition
Max : 5 acquisitions/second

Export the table in csv or xls format
Clear the table



FRONT FACE

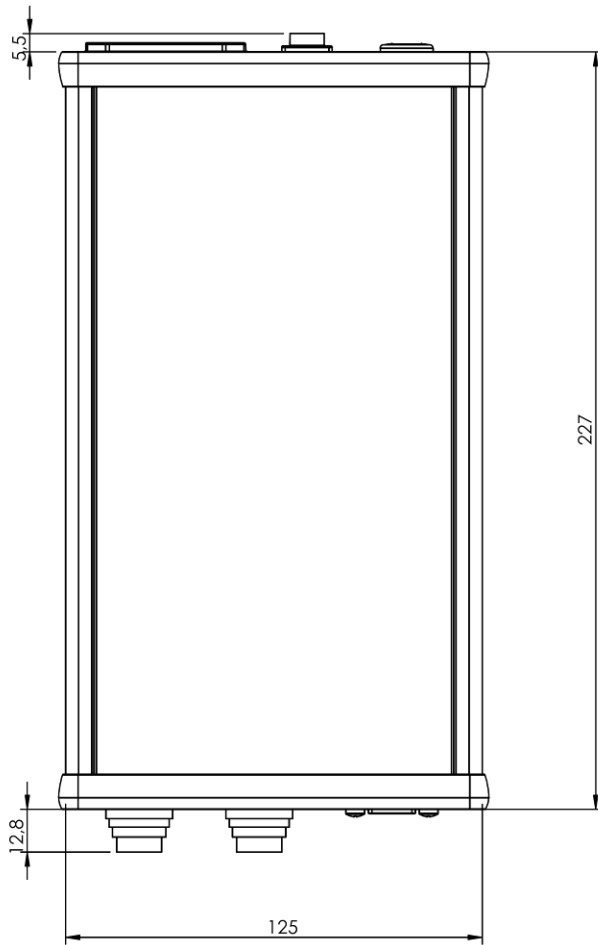

1 analog input

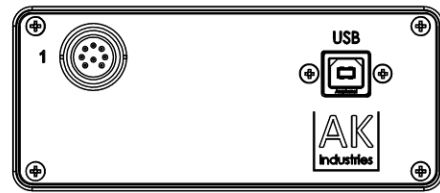

2 analog inputs

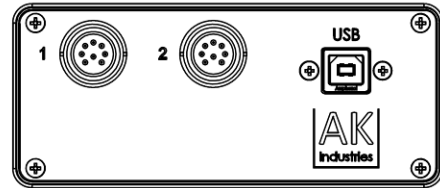

3 analog inputs

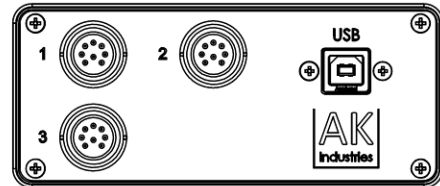

4 analog inputs

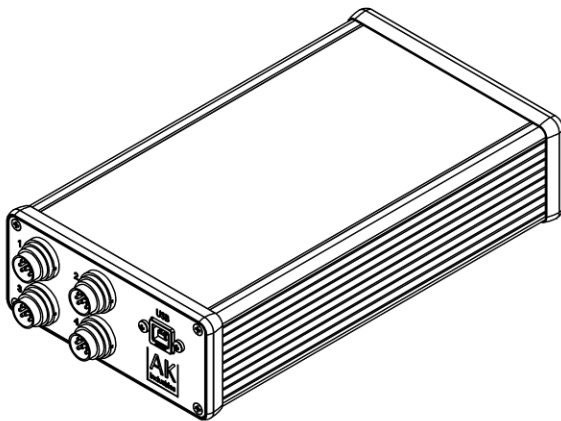
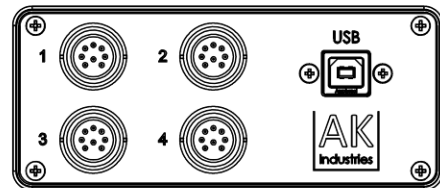

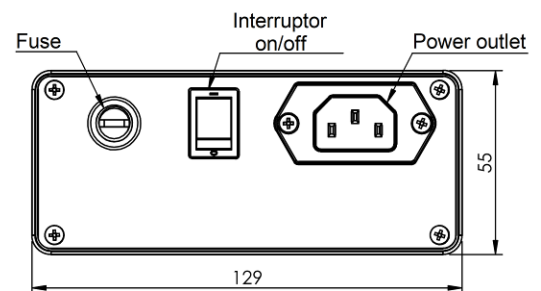

BACK FACE





Connection cable sensor/measurement box

Cable length	Sensor with M16 connector 4 ... 20mA output	Sensor with M16 connector 0 ... 10V output	Sensor with M12 connector 4 ... 20mA output	Sensor with M12 connector 0 ... 10V output
2 m	RAL-M16FD/M16FD-I420-002	RAL-M16FD/M16FD-U010-002	RAL-M16FD/M12FD-I420-002	RAL-M16FD/M12FD-U010-002
5 m	RAL-M16FD/M16FD-I420-005	RAL-M16FD/M16FD-U010-005	RAL-M16FD/M12FD-I420-005	RAL-M16FD/M12FD-U010-005
10 m	RAL-M16FD/M16FD-I420-010	RAL-M16FD/M16FD-U010-010	RAL-M16FD/M12FD-I420-005	RAL-M16FD/M12FD-U010-010

Shielded counter-connectors to assemble

	Straight female connector M16 8 pins DIN Ref : 5100-026	Straight female connector M12 Code A - 4 pins Ref : 5100-065
Ingress protection	IP67	
Temperature of use	-25 ... +90 °C	
Connection	To solder	Screw clamp
Cable diameter	Ø4 to Ø6 mm	
Conductor	0.14 ... 0.34 mm ²	
	Good resistance to oil and chemicals	

ORDERING REFERENCE

